

2.4G remote control car manual 104310

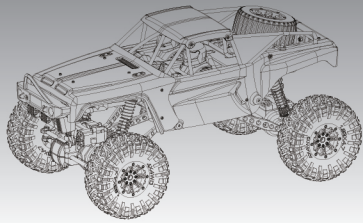

Dear Customer: Thank you for purchasing our products. Please read carefully the manuals provided by this product before operation, and please keep the manuals for future reference if necessary.

1. The main parameters and functions

- | | |
|---|------------------------------------|
| 1. Product Code: 104310 | 11. Charging time: about 2 hours |
| 2. Product Name: 1: 10 electric four - wheel - climbing car | 12. Driving time: about 40 minutes |
| 3. Material: plastic / metal / electronic components | 13. driving speed: 10KM / H |
| 4. Remote control distance: ≥50M | |
| 5. Frequency: 2.4G | |
| 6. Remote control car battery: 7.4V 1200MAH lithium battery | |
| 7. Remote control battery: "AA" 1.5V × 4 (need to buy) | |
| 8. Remote control car size: 472*268*227mm (length X width X height) | |
| 9. Remote control size: 118 × 72 × 179 mm (length X width X height) | |
| 10. Applicable age: 14 years old or above | |

2. Description of function buttons and part names

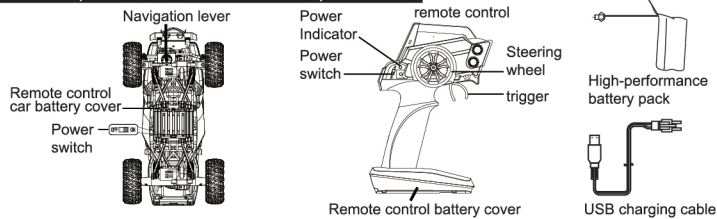

3. Battery installation method

- As shown in Figure 1, open the battery cover of the remote control, insert the correct four AA batteries (sold separately) according to the polarity of the battery box, and then cover the battery cover.
- As shown in Figure 2, open the remote control battery cover, the rechargeable battery pack into the bottom of the battery box, as shown in Figure logo will be the right to connect the power plug, positive on the positive (red), negative on the negative (black), Cover the remote control car battery cover lock screws.

-1-

五、 Operation method

- Turn on the power switch of the remote control car, then turn on the power switch of the remote control. The LED on the remote control will flash regularly. Rotate the steering wheel on the remote control. When the light turns on, the front wheel of the remote control car follows. The steering wheel of the remote control indicates that the code is successful. If the code is not successful, please repeat the above action. After the code is successful, the remote control car can be started.
- Pull back the trigger and the vehicle will go forward. Release the trigger and the vehicle will stop. Pull up the trigger and the vehicle will go backward. And release it, the vehicle will stop. (See figure 1)
- Turn the steering wheel to the left or right, and the front wheel of the vehicle will turn left or right. (See figure 2)
- While controlling the vehicle to go forward, turn the steering wheel left or right at the same time, then the vehicle will turn left or right while running forward. (See figure 3)
- When the control vehicle is moving backwards, turn the steering wheel left or right at the same time, and then the vehicle turns left or right while moving backward (see Figure 4).
- If the vehicle goes to the left while driving straight, fine tune the lever to the right until it runs straight forward. And if the vehicle goes to the right while driving straight, fine tune the lever to the left until it runs straight forward. (See figure 5)

Reminder:

- When the battery of the remote control car is low, the speed of the remote control car will slow down. After about 15 seconds, it will not respond at all. Please charge the battery or replace it with a new full battery to restore the normal power. When the indicator light flashes slowly, it indicates that the remote control battery power has entered the low voltage. In this case, please replace the brand new battery. If the remote control enters the low voltage, if the control continues, the remote control distance may become shorter and the car may lose control. When the remote control car 5 If there is no operation in minutes, the remote control car will enter the sleep mode, and it needs to be re-clocked before it can be operated.
- When the remote control car is used up, turn off the vehicle switch, and then turn off the remote control switch. If it is not used for a long time, remove the battery from the vehicle and remote controller, fully charge the battery and store it properly to avoid electric leakage or vehicle breakdown. , And wipe the product clean with a clean rag.

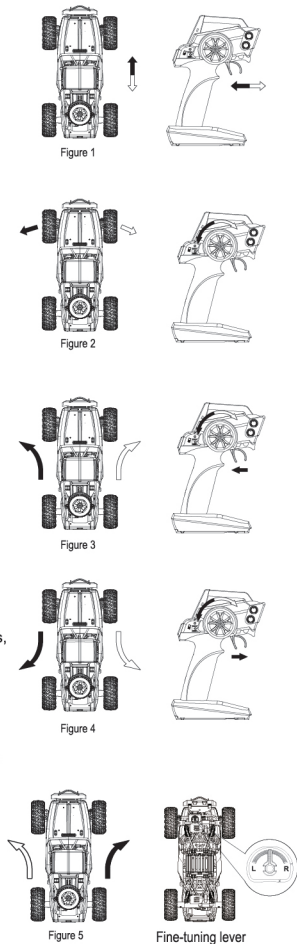

-3-

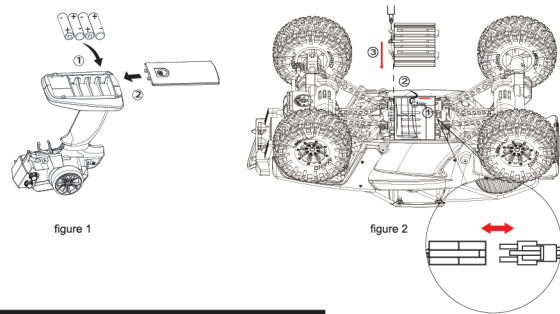

4. Rechargeable battery charging method

- Method One: 1. Connect the USB cable with the adaptor (not included), and plug the adaptor to the power, and then plug the battery to the USB cable. The USB light keeps on, which means it's charging. When the light is off, the charging is complete.
2. The charging time depends on the output of the adaptor. After charging, please disconnect all charging equipments and keep them properly.
- Method Two: 1. Connect the USB cable with the computer, and then plug the battery to the USB cable. The USB light keeps on, which means it's charging. When the light is off, the charging is complete.
2. The charging time depends on the output of the computer. After charging, please disconnect all charging equipment and keep them properly.

Method One

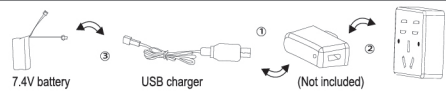

Method Two

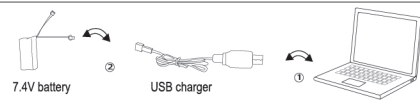

Note:

- ☆ Only charge the product using the USB cable configured for the product battery charging.
- ☆ Do not disassemble or modify the battery at random, so as to avoid fire, explosion and other hazards.
- ☆ Do not drop the battery from the height or into the fire, so as to avoid fire, explosion and other hazards.
- ☆ Do not squeeze the battery, impact, puncture, so as to avoid fire, explosion and other hazards.
- ☆ Do not put the battery in the sun for a long time exposure, in order to avoid danger.
- ☆ After the battery is running, it should be taken out of the remote control car. After the battery is cooled down, it should be fully charged and placed in a safe place. When it is not charging, pull out the battery plug from the USB charging line and disconnect the power.
- ☆ When the battery is stored at a temperature below 30 ° is appropriate, can not be stored in a heat source, high temperature, humidity and other places, so as to avoid danger.
- ☆ While using or charging battery, if it gets small or suddenly turns hot, becomes deformed, changes color or other anomalies, please stop using it at once.
- ☆ After the battery temperature is high, it is recommended to wait about 30 minutes before charging the battery, otherwise it may damage the battery.
- ☆ If you have questions about the battery charging process please contact our company or dealer.

-2-

! Caveat:

- * Please follow the instructions or instructions on the packaging requirements of the correct installation and use, some parts need to be assembled and commissioned by adults.
- * Please use under adult guidance.
- * Keep the packing materials away to avoid harm to children.
- * Do not play in a place where there is water or rain, otherwise it may cause a wet machine malfunction.
- * Do not touch the wheels in rotation to avoid unnecessary injury.
- * The product contains small parts, which may cause danger such as eating or choking.
- * In the street or the crowd is strictly prohibited remote control, so as to avoid accidents.
- * Regularly check the charging USB cable, plug, housing and other components, found to be damaged immediately stop making Use, until the repair intact.
- * This product can only use the original configuration of the USB cable to charge the product battery.
- * The USB cable, battery compartment, and battery must be plugged into the same designated power source as the product logo.
- * The USB cable and batteries are not toys.
- * Disconnect the charging USB cable before cleaning the toy.
- * If you encounter thunder, lightning and other weather when remote control, please stop the remote control immediately.
- * When installing or replacing the battery, it should be noted that the polarity of the battery is correct.
- * Remote control car using rechargeable batteries.
- * Remote control using four 1.5V "AA" batteries (sold separately)
- * Do not short-circuit the battery, decomposition, modification, impact, extrusion, puncture, falling height, into the fire and so on, in order to avoid danger.
- * Do not put the battery in the sun for a long time exposure, in order to avoid danger.
- * When the battery is stored at a temperature below 30 °C is appropriate, can not be stored in a heat source, high temperature, humidity and other places, so as to avoid danger.
- * Non-rechargeable batteries can not be charged.
- * When charging the rechargeable battery, adult monitoring is required.
- * Rechargeable batteries should be removed from the toy before charging.
- * Do not mix new and old batteries or different types of batteries.
- * The exhausted battery should be removed in time.
- * Terminals should not be short-circuited.
- * When not using the product for a long time, remove the remote control car and remote control batteries.
- * Please keep the package and the manual as they contain important information.

-4-

2.4G remote control car manual 104310

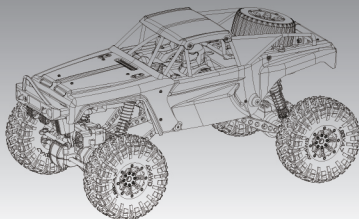

Dear Customer: Thank you for purchasing our products. Please read carefully the manuals provided by this product before operation, and please keep the manuals for future reference if necessary.

1. The main parameters and functions

1. Product Code: 104310
2. Product Name: 1: 10 electric four - wheel - climbing car
3. Material: plastic / metal / electronic components
4. Remote control distance: $\geq 50M$
5. Frequency: 2.4G
6. Remote control car battery: 7.4V 1200MAH lithium battery
7. Remote control battery: "AA" 1.5V $\times 4$ (need to buy)
8. Remote control car size: 472*268*227mm (length X width X height)
9. Remote control size: 118 \times 72 \times 179 mm (length X width X height)
10. Applicable age: 14 years old or above
11. Charging time: about 2 hours
12. Driving time: about 40 minutes
13. driving speed: 10KM / H

2. Description of function buttons and part names

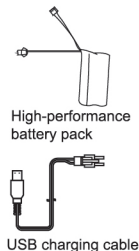
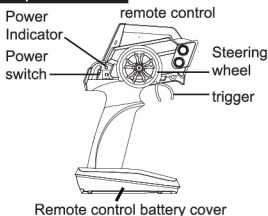
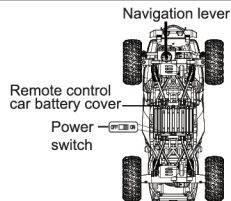

3. Battery installation method

1. As shown in Figure 1, open the battery cover of the remote control, insert the correct four AA batteries (sold separately) according to the polarity of the battery box, and then cover the battery cover.
2. as shown in Figure 2, open the remote control battery cover, the rechargeable battery pack into the bottom of the battery box, as shown in Figure logo will be the right to connect the power plug, positive on the positive (red), negative on the negative (black) , Cover the remote control car battery cover lock screws.

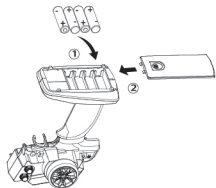

figure 1

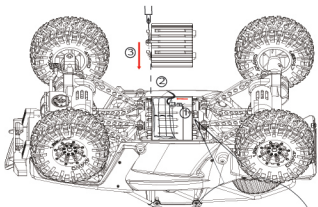
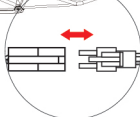

figure 2



4. Rechargeable battery charging method

Method One: 1. Connect the USB cable with the adaptor (not included), and plug the adaptor to the power, and then plug the battery to the USB cable. The USB light keeps on, which means it's charging. When the light is off, the charging is complete.

2. The charging time depends on the output of the adaptor. After charging, please disconnect all charging equipments and keep them properly.

Method Two: 1. Connect the USB cable with the computer, and then plug the battery to the USB cable. The USB light keeps on, which means it's charging. When the light is off, the charging is complete.

2. The charging time depends on the output of the computer. After charging, please disconnect all charging equipment and keep them properly.

Method One

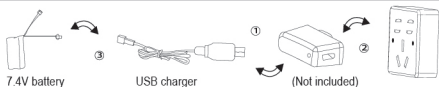

Method Two

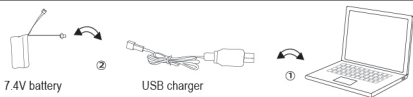

Note:

- ☆ Only charge the product using the USB cable configured for the product battery charging.
- ☆ Do not disassemble or modify the battery at random, so as to avoid fire, explosion and other hazards.
- ☆ Do not drop the battery from the height or into the fire, so as to avoid fire, explosion and other hazards.
- ☆ Do not squeeze the battery, impact, puncture, so as to avoid fire, explosion and other hazards.
- ☆ Do not put the battery in the sun for a long time exposure, in order to avoid danger.
- ☆ After the battery is running, it should be taken out of the remote control car. After the battery is cooled down, it should be fully charged and placed in a safe place. When it is not charging, pull out the battery plug from the USB charging line and disconnect the power.
- ☆ When the battery is stored at a temperature below 30 ° is appropriate, can not be stored in a heat source, high temperature, humidity and other places, so as to avoid danger.
- ☆ While using or charging battery, if it gets smell or suddenly turns hot, becomes deformed, changes color or other anomalies, please stop using it at once.
- ☆ After the battery temperature is high, it is recommended to wait about 30 minutes before charging the battery, otherwise it may damage the battery.
- ☆ If you have questions about the battery charging process please contact our company or dealer.

五、Operation method

1. Turn on the power switch of the remote control car, then turn on the power switch of the remote control. The LED on the remote control will flash regularly. Rotate the steering wheel on the remote control. When the light turns on, the front wheel of the remote control car follows. The steering wheel of the remote control indicates that the code is successful. If the code is not successful, please repeat the above action. After the code is successful, the remote control car can be started.
2. Pull back the trigger and the vehicle will go forward. Release the trigger and the vehicle will stop. Pull up the trigger and the vehicle will go backward. And release it, the vehicle will stop. (See figure 1)
3. Turn the steering wheel to the left or right, and the front wheel of the vehicle will turn left or right. (See figure 2)
4. While controlling the vehicle to go forward, turn the steering wheel left or right at the same time, then the vehicle will turn left or right while running forward. (See figure 3)
5. When the control vehicle is moving backwards, turn the steering wheel left or right at the same time, and then the vehicle turns left or right while moving backward (see Figure 4).
6. If the vehicle goes to the left while driving straight, fine tune the lever to the right until it runs straight forward. And if the vehicle goes to the right while driving straight, fine tune the lever to the left until it runs straight forward. (See figure 5)

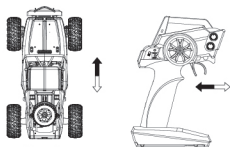

Figure 1

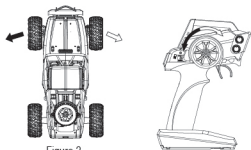

Figure 2

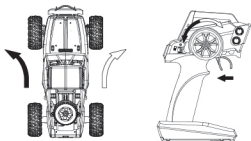

Figure 3

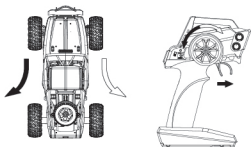

Figure 4

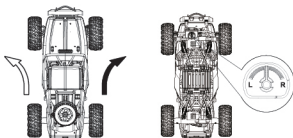

Figure 5

Fine-tuning lever

Reminder:

1. When the battery of the remote control car is low, the speed of the remote control car will slow down. After about 15 seconds, it will not respond at all. Please charge the battery or replace it with a new full battery to restore the normal power. When the indicator light flashes slowly, it indicates that the remote control battery power has entered the low voltage. In this case, please replace the brand new battery. If the remote control enters the low voltage, if the control continues, the remote control distance may become shorter and the car may lose control. When the remote control car 5 If there is no operation in minutes, the remote control car will enter the sleep mode, and it needs to be re-clocked before it can be operated.
2. When the remote control car is used up, turn off the vehicle switch, and then turn off the remote control switch. If it is not used for a long time, remove the battery from the vehicle and remote controller, fully charge the battery and store it properly to avoid electric leakage or vehicle breakdown. , And wipe the product clean with a clean rag.



Caveat:

- * Please follow the instructions or instructions on the packaging requirements of the correct installation and use, some parts need to be assembled and commissioned by adults.
- * Please use under adult guidance.
- * Keep the packing materials away to avoid harm to children.
- * Do not play in a place where there is water or rain, otherwise it may cause a wet machine malfunction.
- * Do not touch the wheels in rotation to avoid unnecessary injury.
- * The product contains small parts, which may cause danger such as eating or choking.
- * In the street or the crowd is strictly prohibited remote control, so as to avoid accidents.
- * Regularly check the charging USB cable, plug, housing and other components, found to be damaged immediately stop making Use, until the repair intact.
- * This product can only use the original configuration of the USB cable to charge the product battery.
- * The USB cable, battery compartment, and battery must be plugged into the same designated power source as the product logo.
- * The USB cable and batteries are not toys.
- * Disconnect the charging USB cable before cleaning the toy.
- * If you encounter thunder, lightning and other weather when remote control, please stop the remote control immediately.
- * When installing or replacing the battery, it should be noted that the polarity of the battery is correct.
- * Remote control car using rechargeable batteries.
- * Remote control using four 1.5V "AA" batteries (sold separately)
- * Do not short-circuit the battery, decomposition, modification, impact, extrusion, puncture, falling height, into the fire and so on, in order to avoid danger.
- * Do not put the battery in the sun for a long time exposure, in order to avoid danger.
- * When the battery is stored at a temperature below 30 °C is appropriate, can not be stored in a heat source, high temperature, humidity and other places, so as to avoid danger.
- * Non-rechargeable batteries can not be charged.
- * When charging the rechargeable battery, adult monitoring is required.
- * Rechargeable batteries should be removed from the toy before charging.
- * Do not mix new and old batteries or different types of batteries.
- * The exhausted battery should be removed in time.
- * Terminals should not be short-circuited.
- * When not using the product for a long time, remove the remote control car and remote control batteries.
- * Please keep the package and the manual as they contain important information.